



INSTRUKCJA MONTAŻU ZESTAWÓW

PORADY DO MONTAŻU

- przed przystąpieniem do prac zapoznaj się z **instrukcją montażu**
- dokładnie wymierz i zaznacz lokalizacje otworów pod wkręty na ścianie
- zanim wywiercić otwory w ścianie sprawdź ich poprawność przykładając półki do ściany
- sprawdź poprawność poziomów zaznaczonych otworów pod poszczególne elementy
- w razie pytań lub wątpliwości zgłoś się do producenta

SPIS TREŚCI

KOMPOZYCJE MAŁE

TANA SET S01	str.5
TANA SET S02	str.6
TANA SET S03	str.7

KOMPOZYCJE ŚREDNIE

TANA SET M01	str.9
TANA SET M02	str.10
TANA SET M03	str.11
TANA SET M04	str.12
TANA SET M05	str.13
TANA SET M06	str.14

KOMPOZYCJE DUŻE

TANA SET L01	str.16
TANA SET L02	str.17
TANA SET L03	str.18

ZESTAWY MAŁE

TANA SET S01

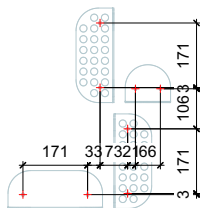
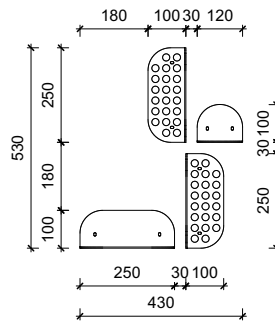

TANA SET S02

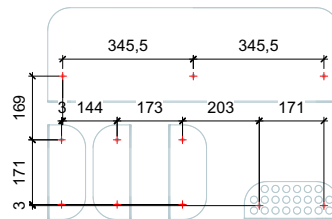
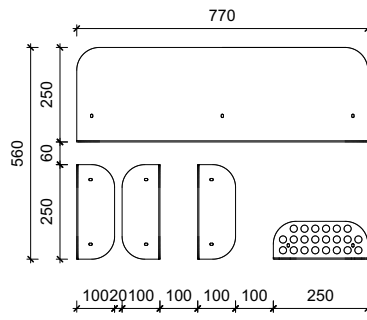

TANA SET S03

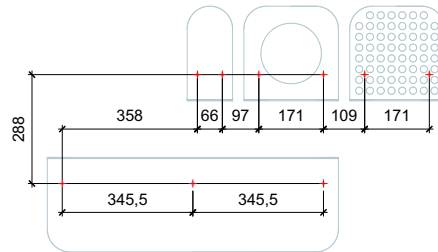
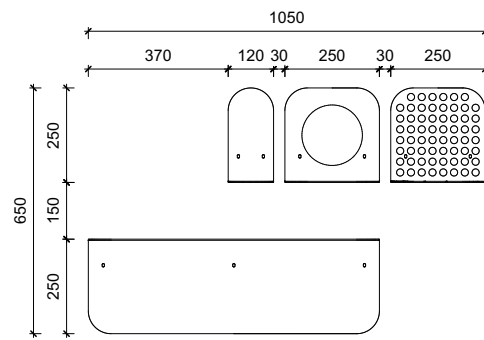

ZESTAWY ŚREDNIE

TANA SET M01

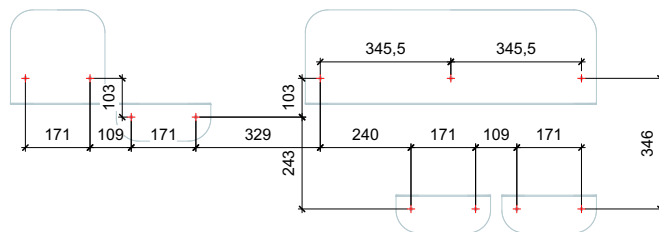
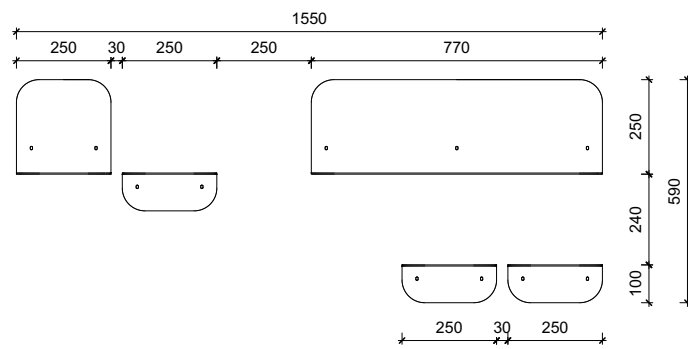

TANA SET M02

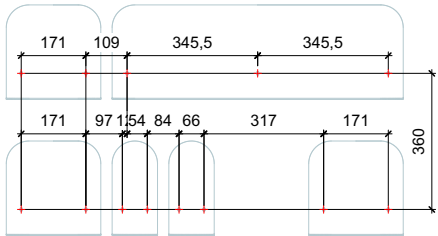
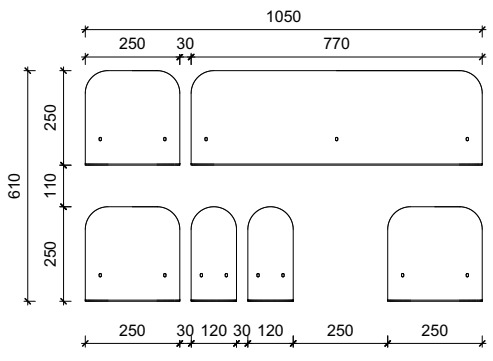

TANA SET M03

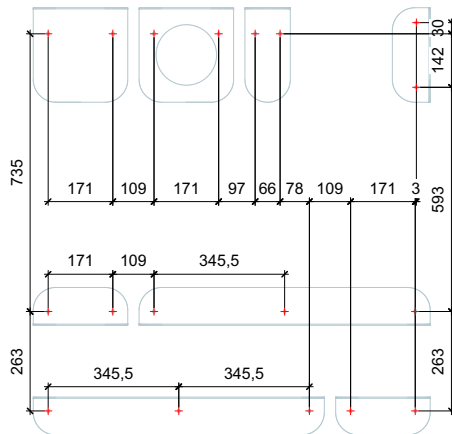
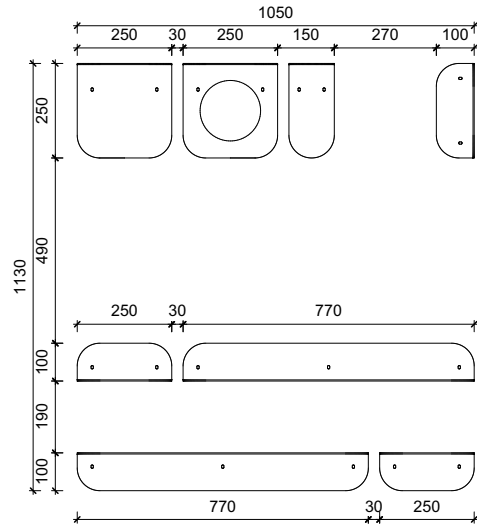

TANA SET M04

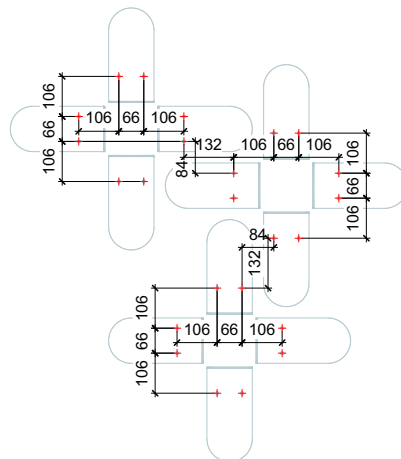
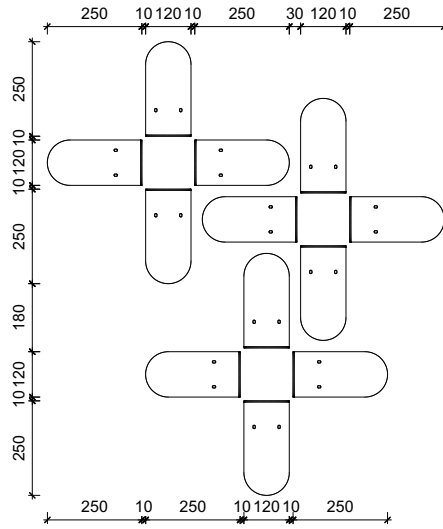

TANA SET M05

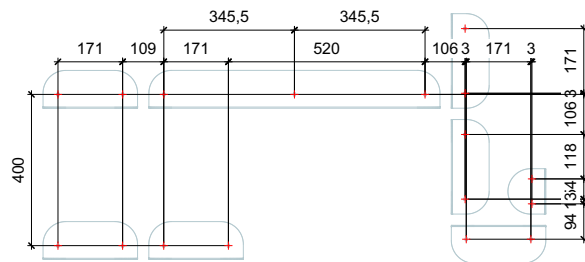
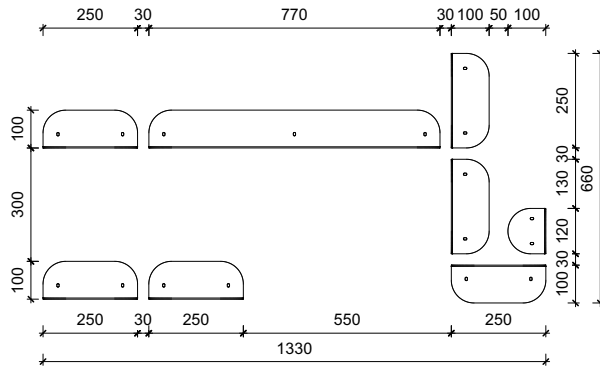

TANA SET M06

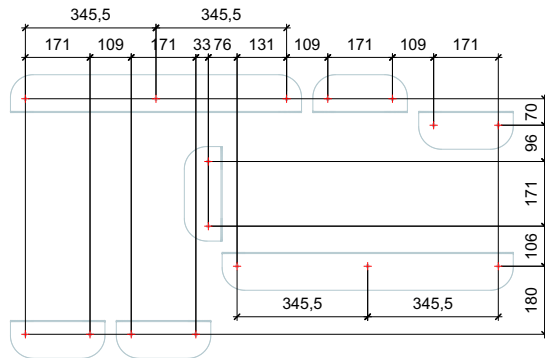
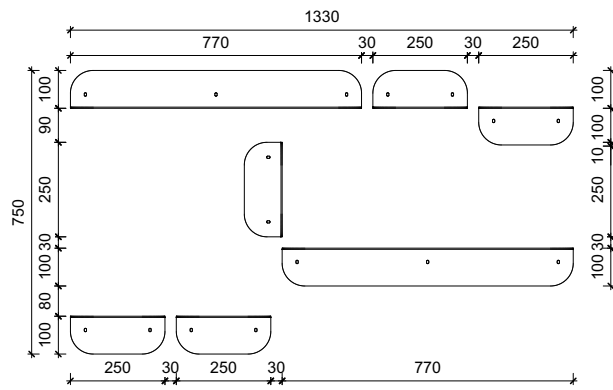

ZESTAWY DUŻE

TANA SET L01

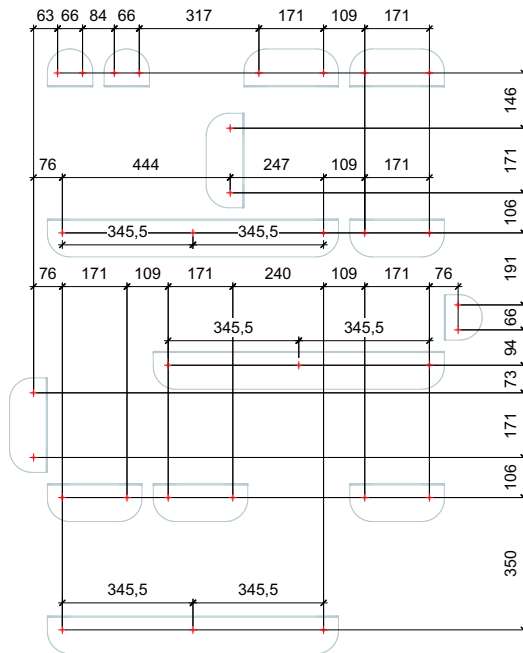
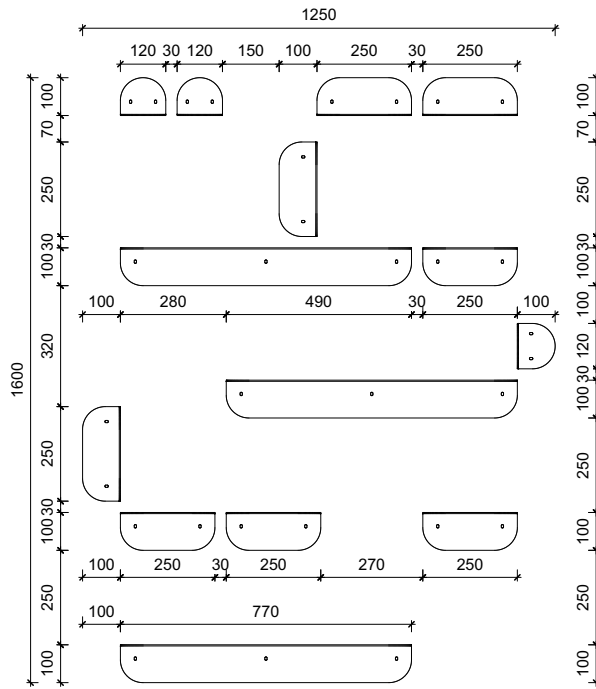

TANA SET L02

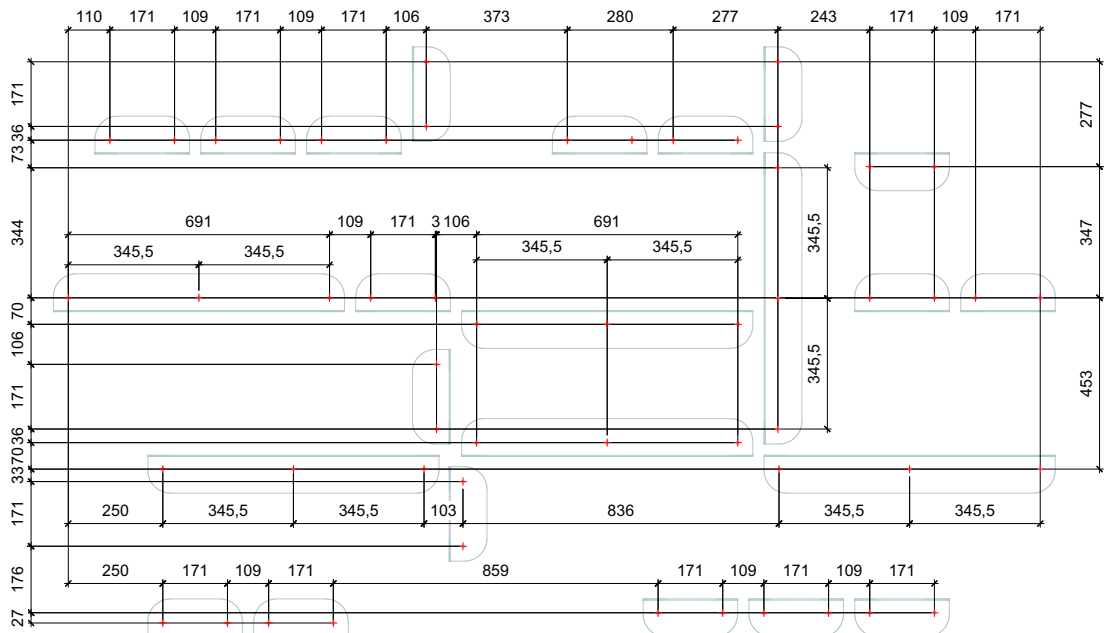
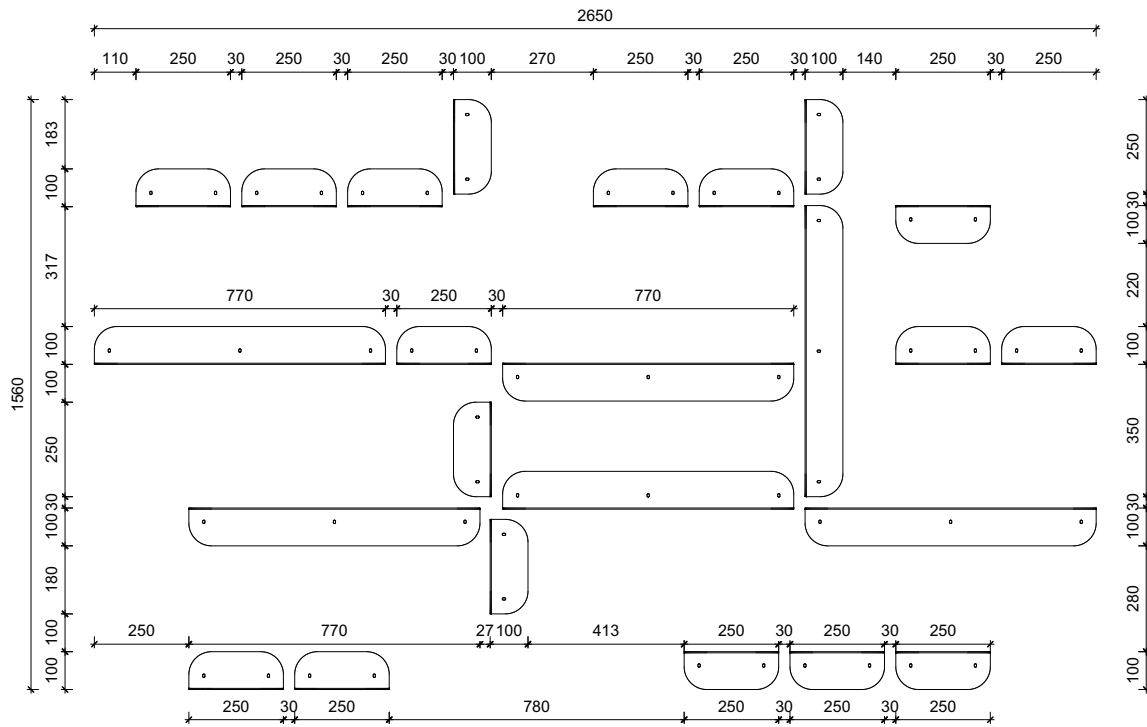

TANA SET L03

